

- 896 × 1 Sensor-Element Organization
- 200 Dots-Per-Inch (DPI) Sensor Pitch
- High Linearity and Uniformity
- Wide Dynamic Range . . . 2000:1 (66 dB)
- Output Referenced to Ground
- Low Image Lag . . . 0.5% Typ
- Operation to 5 MHz
- Single 5-V Supply
- 112 mm Active Length

Description

The TSL2014 linear sensor array consists of two sections of 448 photodiodes and associated charge amplifier circuitry that can be connected to form a contiguous 896 × 1 array. The pixels measure 120 μm (H) by 70 μm (W) with 125-μm center-to-center spacing and 55-μm spacing between pixels. Operation is simplified by internal control logic that requires only a serial-input (SI) signal and a clock.

The TSL2014 is intended for use in a wide variety of applications including mark detection and code reading, optical character recognition (OCR) and contact imaging, edge detection and positioning as well as optical linear and rotary encoding.

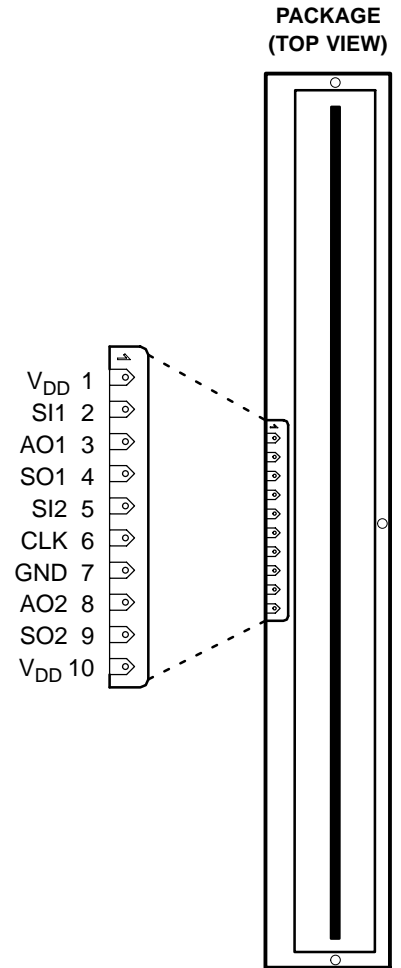

Functional Block Diagram (each section)

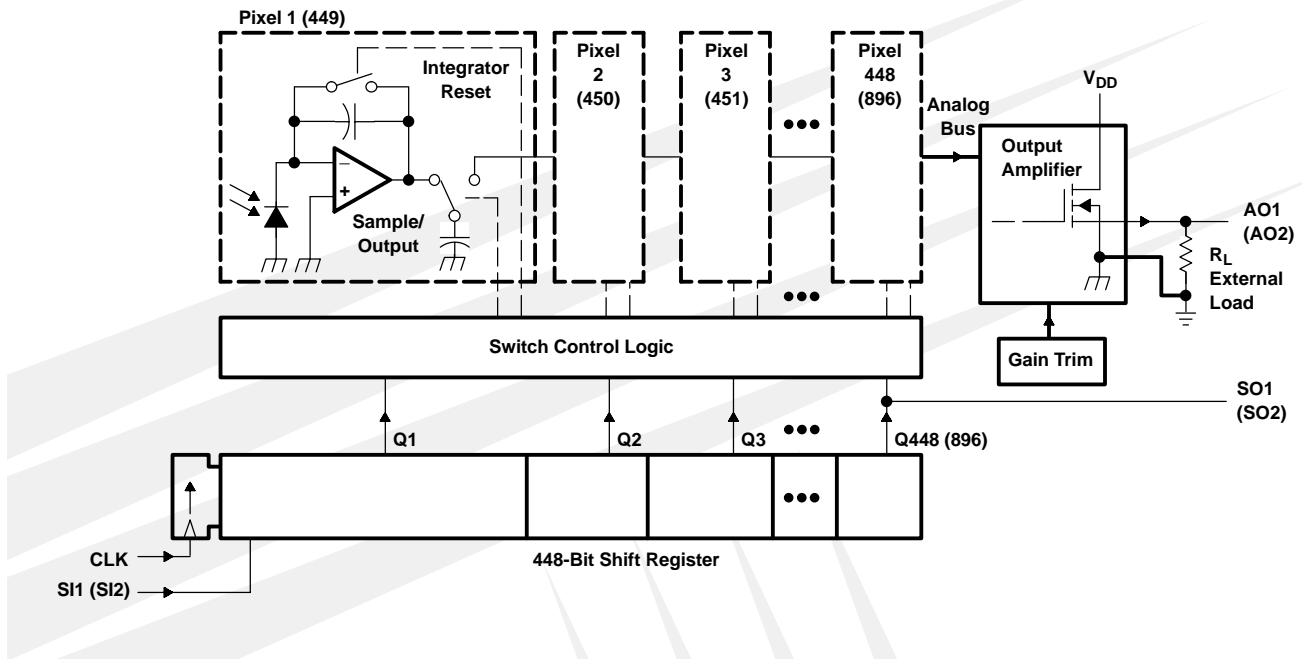

TSL2014

896 × 1 LINEAR SENSOR ARRAY

TAOS040A – MARCH 2004

Terminal Functions

TERMINAL NAME	NO.	I/O	DESCRIPTION
AO1	3	O	Analog output of section 1.
AO2	8	O	Analog output of section 2.
CLK	6	I	Clock. The clock controls the charge transfer, pixel output and reset.
GND	7		Ground (substrate). All voltages are referenced to GND.
SI1	2	I	Serial input (section 1). SI1 defines the start of the data-out sequence.
SI2	5	I	Serial input (section 2). SI2 defines the start of the data-out sequence.
SO1	4	O	Serial output (section 1). SO1 signals the end of the data out sequence and provides a signal to drive the input of section 2 (SI2) in serial mode.
SO2	9	O	Serial output (section 2). SO2 signals the end of the data out sequence and provides a signal to drive the input of another device for cascading.
VDD	1, 10		Supply voltage. Supply voltage for both analog and digital circuits.

Detailed Description

The sensor consists of 896 photodiodes arranged in a linear array. Light energy impinging on a photodiode generates photocurrent, which is integrated by the active integration circuitry associated with that pixel. During the integration period, a sampling capacitor connects to the output of the integrator through an analog switch. The amount of charge accumulated at each pixel is directly proportional to the light intensity and the integration time. The integration time is the interval between two consecutive output periods.

The output and reset of the integrators is controlled by two 448-bit shift registers and reset logic. A 448-pixel output cycle is initiated by clocking in a logic 1 into the SI input of a section for one positive going clock edge (see Figures 1 and 2)[†]. The two 448-pixel sections may be operated independently using a single clock input or connected in series to form a 896-pixel array. Each section has an independent output (AO), which may be connected together for the 896-pixel function.

When operating in the 896-pixel mode, as the SI pulse is clocked through the 896-bit shift register, the charge on the sampling capacitor of each pixel is sequentially connected to a charge-coupled output amplifier that generates a voltage output, AO. When the bit position goes low, the pixel integrator is reset. On the 897th clock rising edge, the SI pulse is clocked out of the shift register (SI2) and the output assumes a high-impedance state. Note that this 897th clock pulse is required to terminate the output of the 896th pixel and return the internal logic to a known state. A subsequent SI pulse can be presented as early as the 898th clock pulse, thereby initiating another pixel output cycle.

The voltage developed at analog output (AO) is given by:

$$V_{out} = V_{drk} + (R_e) (E_e) (t_{int})$$

where:

- V_{out} is the analog output voltage for white condition
- V_{drk} is the analog output voltage for dark condition
- R_e is the device responsivity for a given wavelength of light given in $V/(\mu J/cm^2)$
- E_e is the incident irradiance in $\mu W/cm^2$
- t_{int} is integration time in seconds

AO is driven by a source follower that requires an external pulldown resistor (330- Ω typical). The output is nominally 0 V for no light input, 2 V for normal white-level, and 3.4 V for saturation light level. When the device is not in the output phase, AO is in a high impedance state.

A 0.1 μF bypass capacitor should be connected between V_{DD} and ground as close as possible to the device.

[†] For proper operation, after meeting the minimum hold time condition, SI must go low before the next rising edge of the clock.

Absolute Maximum Ratings†

Supply voltage range, V_{DD}	-0.3 V to 6 V
Input voltage range, V_I	-0.3 V to $V_{DD} + 0.3V$
Input clamp current, I_{IK} ($V_I < 0$ or $V_I > V_{DD}$)	-20 mA to 20 mA
Output clamp current, I_{OK} ($V_O < 0$ or $V_O > V_{DD}$)	-25 mA to 25 mA
Voltage range applied to any output in the high impedance or power-off state, V_O	-0.3 V to $V_{DD} + 0.3V$
Continuous output current, I_O ($V_O = 0$ to V_{DD})	-25 mA to 25 mA
Continuous current through V_{DD} or GND	-150 mA to 150 mA
Analog output current range, I_O	-25 mA to 25 mA
Operating free-air temperature range, T_A	-25°C to 85°C
Storage temperature range, T_{stg}	-25°C to 85°C
Lead temperature on solder pads for 10 seconds	260°C
ESD tolerance, human body model	2000 V

† Stresses beyond those listed under “Absolute Maximum Ratings” may cause permanent damage to the device. These are stress ratings only, and functional operation of the device at these or any other conditions beyond those indicated under “Recommended Operating Conditions” is not implied. Exposure to absolute-maximum-rated conditions for extended periods may affect device reliability.

Recommended Operating Conditions (see Figure 1 and Figure 2)

	MIN	NOM	MAX	UNIT
Supply voltage, V_{DD}	4.5	5	5.5	V
Input voltage, V_I	0		V_{DD}	V
High-level input voltage, V_{IH}	2		V_{DD}	V
Low-level input voltage, V_{IL}	0		0.8	V
Wavelength of light source, λ	400		1000	nm
Clock frequency, f_{clock}	5		5000	kHz
Sensor integration time, serial t_{int}	0.1792		100	ms
Sensor integration time, parallel t_{int}	0.090		100	ms
Operating free-air temperature, T_A	0		70	°C
Load resistance, R_L	300		4700	Ω
Load capacitance, C_L			330	pF

TSL2014

896 × 1 LINEAR SENSOR ARRAY

TAOS040A – MARCH 2004

Electrical Characteristics at $f_{\text{clock}} = 200 \text{ kHz}$, $V_{\text{DD}} = 5 \text{ V}$, $T_{\text{A}} = 25^{\circ}\text{C}$, $\lambda_{\text{p}} = 640 \text{ nm}$, $t_{\text{int}} = 5 \text{ ms}$, $R_{\text{L}} = 330 \ \Omega$, $E_{\text{e}} = 18 \mu\text{W}/\text{cm}^2$ (unless otherwise noted)

PARAMETER		TEST CONDITIONS	MIN	TYP	MAX	UNIT
V_{out}	Analog output voltage (white, average over 896 pixels)	See Note 1	1.6	2	2.4	V
V_{drk}	Analog output voltage (dark, average over 896 pixels)		0	0.05	0.15	V
PRNU	Pixel response nonuniformity	See Notes 2 & 3		7%	20%	
	Nonlinearity of analog output voltage	See Note 3		±0.4%		FS
	Output noise voltage	See Note 4		1		mVrms
R_{e}	Responsivity		16	22	28	V/ ($\mu\text{J}/\text{cm}^2$)
SE	Saturation exposure	See Note 5		155		nJ/cm ²
V_{sat}	Analog output saturation voltage		2.5	3.4		V
DSNU	Dark signal nonuniformity	All pixels See Note 6		25	120	mV
IL	Image lag	See Note 7		0.5%		
I_{DD}	Supply current, output idle			53	80	mA
I_{IH}	High-level input current	$V_{\text{I}} = V_{\text{DD}}$			10	μA
I_{IL}	Low-level input current	$V_{\text{I}} = 0$			10	μA
V_{OH}	High-level output voltage, SO1 and SO2	$I_{\text{O}} = 50 \ \mu\text{A}$	4.5	4.95		V
		$I_{\text{O}} = 4 \ \text{mA}$		4.6		
V_{OL}	Low-level output voltage, SO1 and SO2	$I_{\text{O}} = 50 \ \mu\text{A}$		0.01	0.1	V
		$I_{\text{O}} = 4 \ \text{mA}$		0.4		
$C_{\text{i(SI)}}$	Input capacitance, SI			35		pF
$C_{\text{i(CLK)}}$	Input capacitance, CLK			70		pF

- NOTES:
- The array is uniformly illuminated with a diffused LED source having a peak wavelength of 640 nm.
 - PRNU is the maximum difference between the voltage from any single pixel and the average output voltage from all pixels of the device under test when the array is uniformly illuminated at the white irradiance level. PRNU includes DSNU.
 - Nonlinearity is defined as the maximum deviation from a best-fit straight line over the dark-to-white irradiance levels, as a percent of analog output voltage (white).
 - RMS noise is the standard deviation of a single-pixel output under constant illumination as observed over a 5-second period.
 - Minimum saturation exposure is calculated using the minimum V_{sat} , the maximum V_{drk} , and the maximum R_{e} .
 - DSNU is the difference between the maximum and minimum output voltage in the absence of illumination.
 - Image lag is a residual signal left in a pixel from a previous exposure. It is defined as a percent of white-level signal remaining after a pixel is exposed to a white condition followed by a dark condition:

$$IL = \frac{V_{\text{out(IL)}} - V_{\text{drk}}}{V_{\text{out(white)}} - V_{\text{drk}}} \times 100$$

Timing Requirements (see Figure 1 and Figure 2)

		MIN	NOM	MAX	UNIT
$t_{\text{su(SI)}}$	Setup time, serial input (see Note 8)	20			ns
$t_{\text{h(SI)}}$	Hold time, serial input (see Note 8 and Note 9)	0			ns
t_{w}	Pulse duration, clock high or low	50			ns
$t_{\text{r}}, t_{\text{f}}$	Input transition (rise and fall) time	0		500	ns

- NOTES:
- Input pulses have the following characteristics: $t_{\text{r}} = 6 \text{ ns}$, $t_{\text{f}} = 6 \text{ ns}$.
 - SI must go low before the rising edge of the next clock pulse.

Dynamic Characteristics over recommended ranges of supply voltage and operating free-air temperature (see Figure 2)

PARAMETER	TEST CONDITIONS	MIN	TYP	MAX	UNIT
t_s	Analog output settling time to $\pm 1\%$		185		ns
t_{pd}	Propagation delay time, SO1 and SO2		50		ns

TYPICAL CHARACTERISTICS

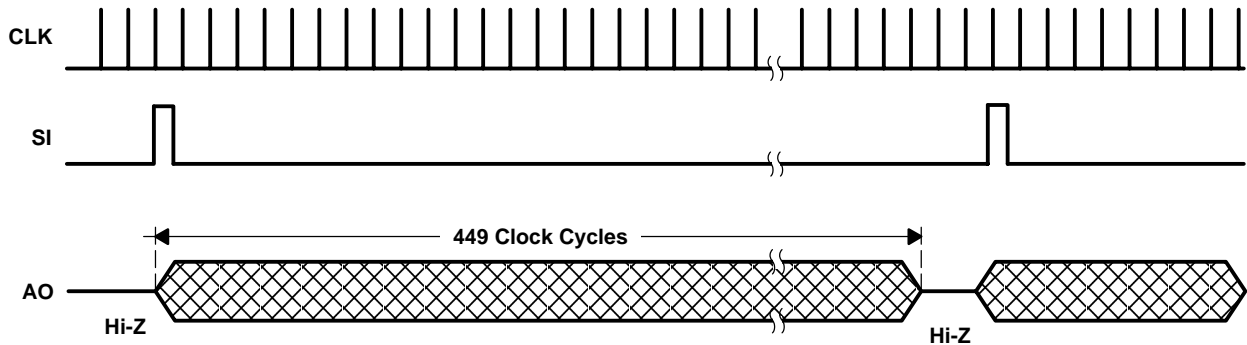

Figure 1. Timing Waveforms (each section)

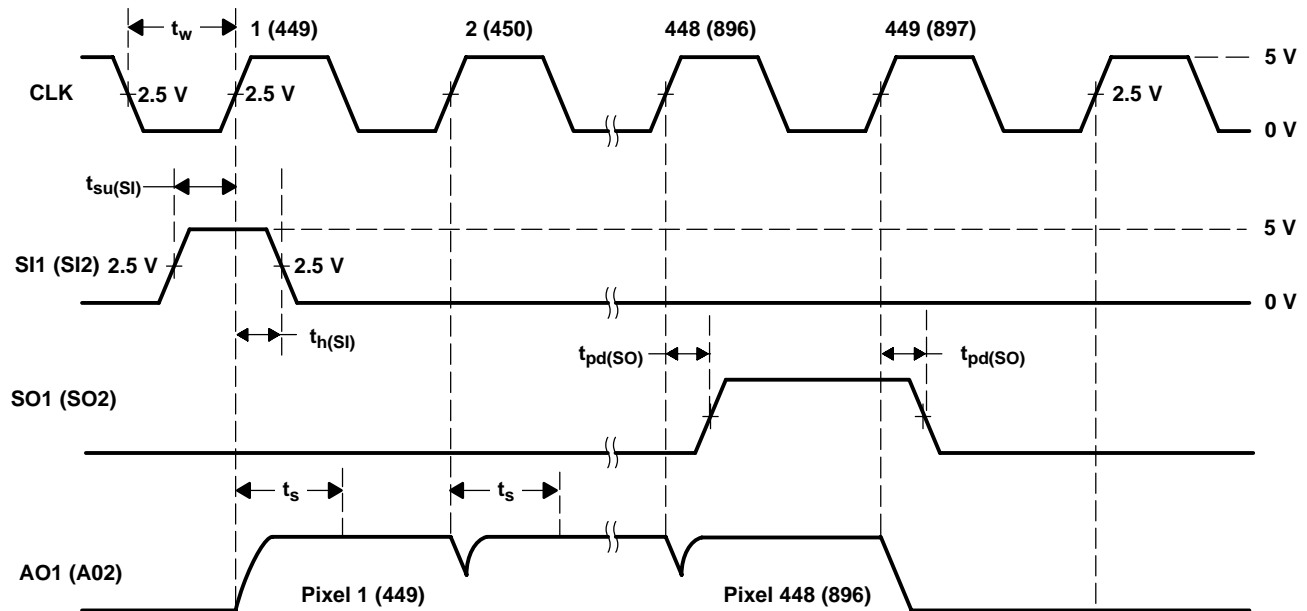

Figure 2. Operational Waveforms (each section)

TSL2014

896 × 1 LINEAR SENSOR ARRAY

TAOS040A – MARCH 2004

TYPICAL CHARACTERISTICS

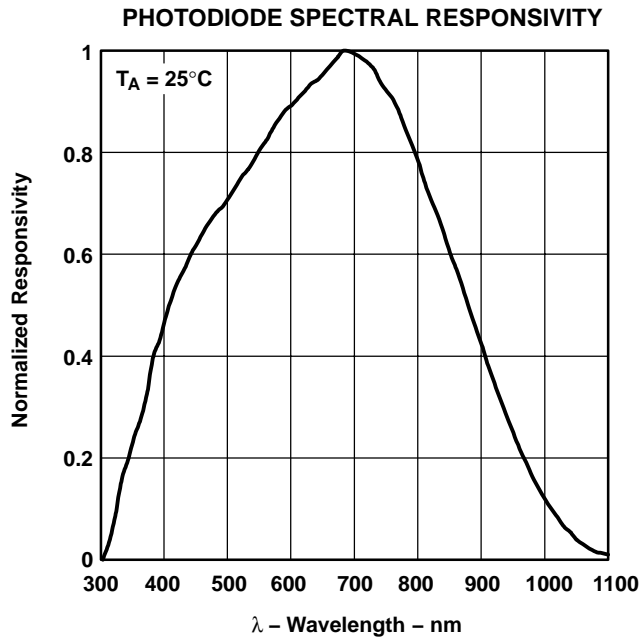

Figure 3

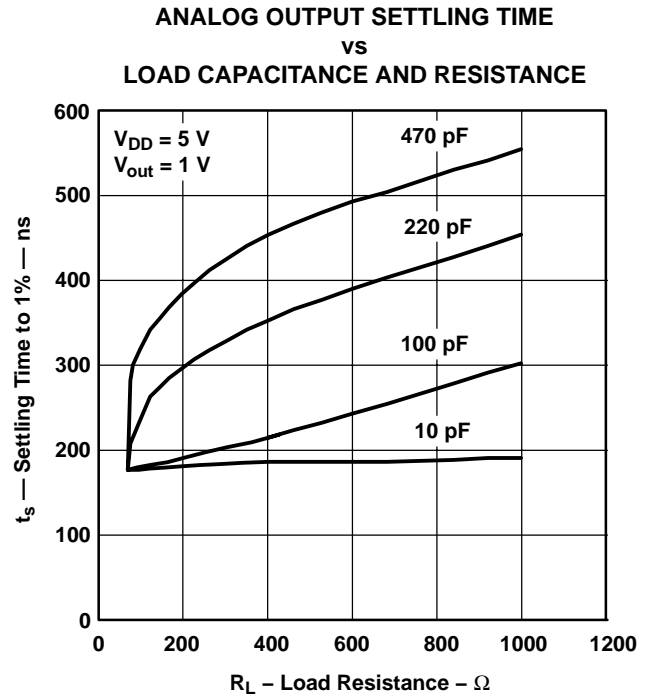

Figure 4

APPLICATION INFORMATION

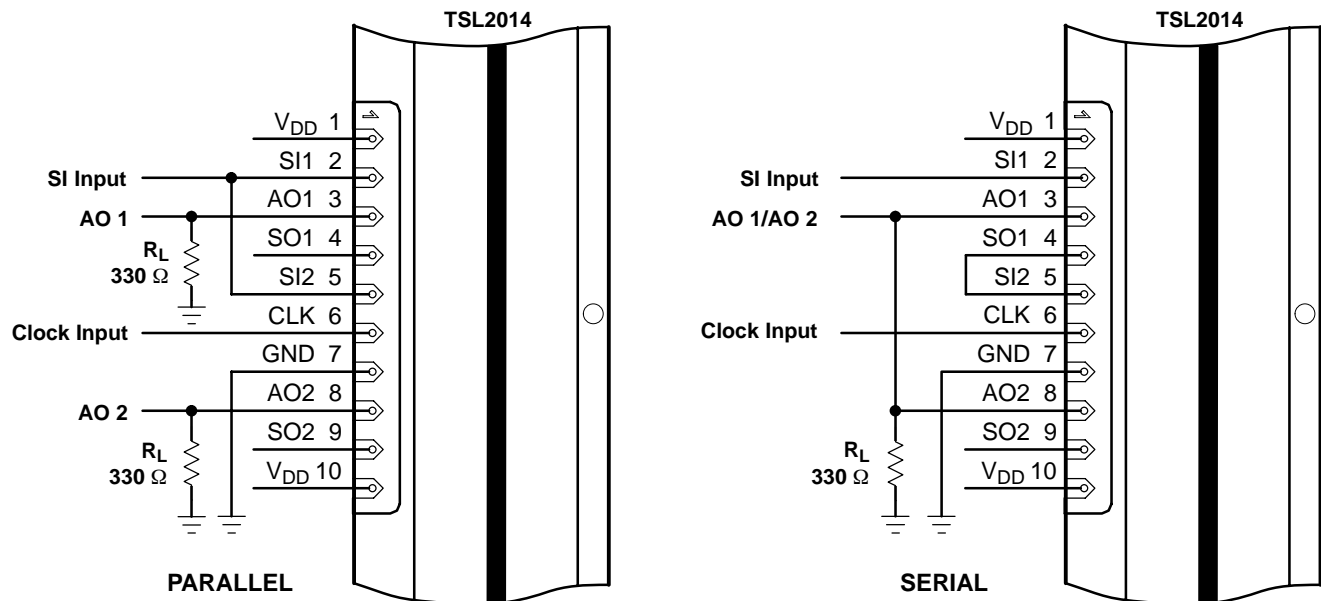
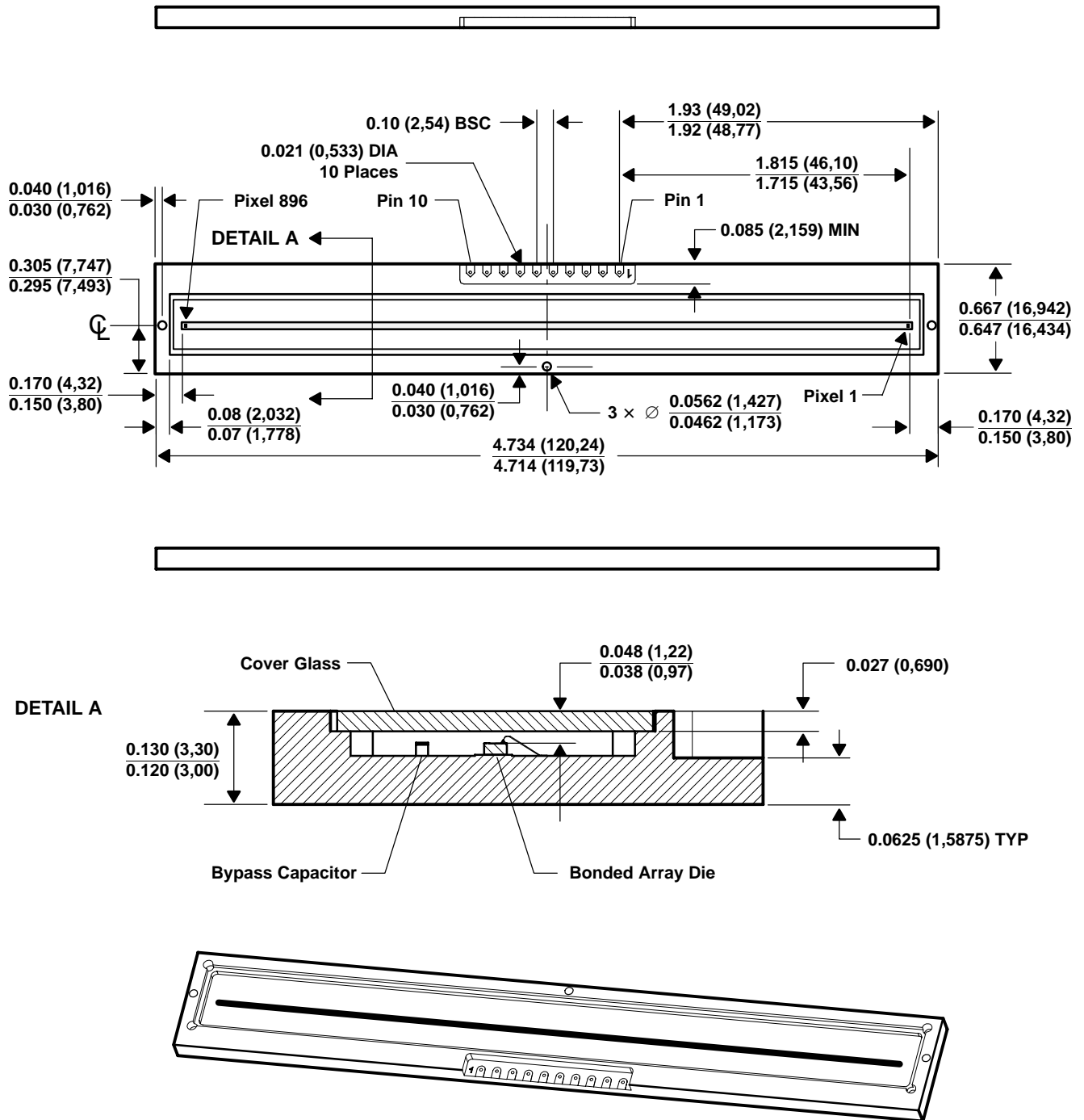

Figure 5. Connection Diagrams

MECHANICAL INFORMATION



- NOTES: A. All linear dimensions are in inches (millimeters).
 B. Cover glass index of refraction is 1.52.
 C. Pixel centers are located along the centerline of the mounting holes.
 D. This drawing is subject to change without notice.

Figure 6. TSL2014 Mechanical Specifications

TSL2014

896 × 1 LINEAR SENSOR ARRAY

TAOS040A – MARCH 2004

PRODUCTION DATA — information in this document is current at publication date. Products conform to specifications in accordance with the terms of Texas Advanced Optoelectronic Solutions, Inc. standard warranty. Production processing does not necessarily include testing of all parameters.

NOTICE

Texas Advanced Optoelectronic Solutions, Inc. (TAOS) reserves the right to make changes to the products contained in this document to improve performance or for any other purpose, or to discontinue them without notice. Customers are advised to contact TAOS to obtain the latest product information before placing orders or designing TAOS products into systems.

TAOS assumes no responsibility for the use of any products or circuits described in this document or customer product design, conveys no license, either expressed or implied, under any patent or other right, and makes no representation that the circuits are free of patent infringement. TAOS further makes no claim as to the suitability of its products for any particular purpose, nor does TAOS assume any liability arising out of the use of any product or circuit, and specifically disclaims any and all liability, including without limitation consequential or incidental damages.

TEXAS ADVANCED OPTOELECTRONIC SOLUTIONS, INC. PRODUCTS ARE NOT DESIGNED OR INTENDED FOR USE IN CRITICAL APPLICATIONS IN WHICH THE FAILURE OR MALFUNCTION OF THE TAOS PRODUCT MAY RESULT IN PERSONAL INJURY OR DEATH. USE OF TAOS PRODUCTS IN LIFE SUPPORT SYSTEMS IS EXPRESSLY UNAUTHORIZED AND ANY SUCH USE BY A CUSTOMER IS COMPLETELY AT THE CUSTOMER'S RISK.

LUMENOLOGY, TAOS, the TAOS logo, and Texas Advanced Optoelectronic Solutions are registered trademarks of Texas Advanced Optoelectronic Solutions Incorporated.